

Chip Resistor Arrays

CRC Series (Convex Square Corner Type)

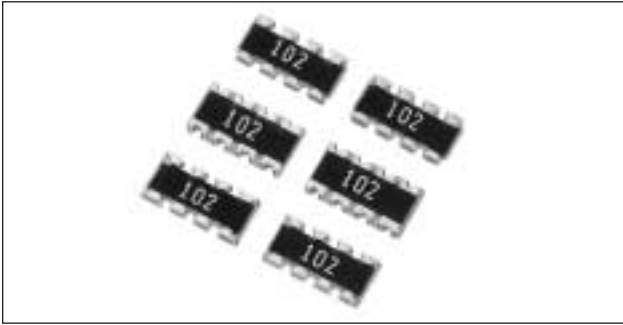

Chip Resistor Arrays have several resistor elements integrated as a single component.

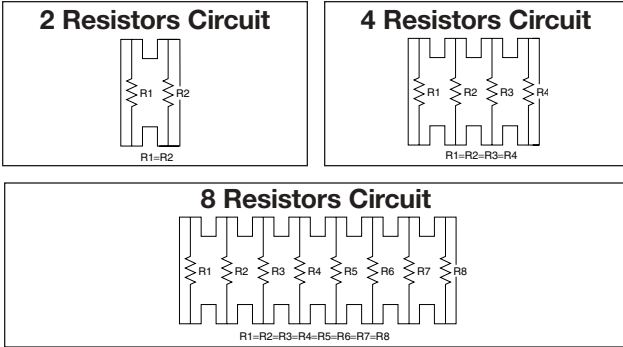

FEATURES

- Reduction in mounting process & costs
- Save PCB space
- Reduction of inventory control costs

APPLICATIONS

- Computer
- Hard Disk Drive
- Printer
- CD-ROM

HOW TO ORDER

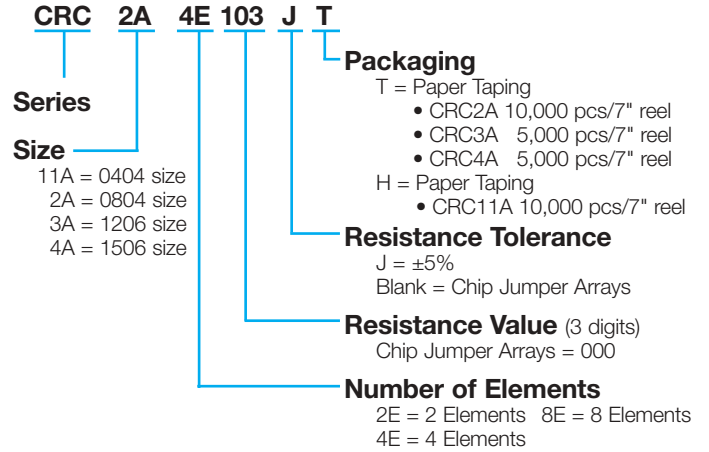

RATING

Chip Resistor Arrays	
Item	Rating
Rated Power (70°C)*	1/16W Element
Max. Working Voltage	50V (25V CRC4A)
Max. Overload Voltage	100V (50V CRC4A)
Resistance Value	J = 10Ω to 2.2MΩ (CRC4A8E 1MΩ max.)
Tolerance	J $\pm 5\%$
Working Temperature	-55 to +125°C

Chip Jumper Arrays	
Item	Rating
Rated Current	1A
Conductive Resistance Value	50MΩ max.
Resistance Value	Zero ohms (0 \pm .5 ohms)
Working Temperature	-55 to +125°C

*Rated voltage = 50V or $\sqrt{\text{Rated power} \times \text{Resistance value}}$, whichever is less

DIMENSIONS

millimeters (inches)

Code	W	L	c	d	t	P		
Dim.	1.00 \pm 0.10 (0.040 \pm 0.004)	1.00 \pm 0.10 (0.040 \pm 0.004)	0.20 \pm 0.15 (0.008 \pm 0.006)	0.20 \pm 0.15 (0.008 \pm 0.006)	0.35 \pm 0.06 (0.014 \pm 0.002)	0.65 typ (0.026 typ)		
No Marking on chips								
Code	L	W	T	P	c	d	e1	e2
Dim.	2.00 \pm 0.10 (0.079 \pm 0.004)	1.00 \pm 0.10 (0.039 \pm 0.004)	0.40 \pm 0.10 (0.016 \pm 0.004)	0.50 typ (0.020 typ)	0.15 \pm 0.15 (0.006 \pm 0.006)	0.25 \pm 0.15 (0.010 \pm 0.006)	0.30 \pm 0.10 (0.012 \pm 0.004)	0.40 \pm 0.10 (0.016 \pm 0.004)
No Marking on chips								
Code	W	L	c	d	T	P		
Dim.	1.60 \pm 0.15 (0.063 \pm 0.006)	3.20 \pm 0.15 (0.126 \pm 0.006)	0.30 \pm 0.20 (0.012 \pm 0.008)	0.20 \pm 0.15 (0.008 \pm 0.006)	0.50 \pm 0.10 (0.020 \pm 0.004)	0.80 typ (0.031 typ)		
No Marking on chips								
Code	L	W	T	P	c	d	e	
Dim.	3.80 \pm 0.10 (0.150 \pm 0.004)	1.60 \pm 0.10 (0.063 \pm 0.004)	0.45 \pm 0.10 (0.018 \pm 0.004)	0.50 typ (0.020 typ)	0.30 \pm 0.20 (0.012 \pm 0.008)	0.30 \pm 0.15 (0.012 \pm 0.006)	0.30 \pm 0.10 (0.012 \pm 0.004)	
No Marking on chips								

Chip Resistor Arrays



CR, CJ, CRA, CRB, CRC Series - Test Conditions

ELECTRICAL CHARACTERISTICS

Item	Standard		Test Conditions												
	Resistor	Jumper	Resistor	Jumper											
DC Resistance	Within Initial Tolerance		Power Condition A (20°C, 65% RH)												
Temperature Characteristics	<table border="1"> <thead> <tr> <th>Resistance (Ω)</th> <th>TCR (ppm/°C)</th> </tr> </thead> <tbody> <tr> <td>[*]D, F 10 ≤ R ≤ 1M</td> <td>-100 to +100</td> </tr> <tr> <td>J, CR05 = F R < 10</td> <td>-100 to +600</td> </tr> <tr> <td>10 ≤ R ≤ 1M</td> <td>-250 to +250</td> </tr> <tr> <td>1M < R</td> <td>-500 to +300</td> </tr> </tbody> </table>		Resistance (Ω)	TCR (ppm/°C)	[*] D, F 10 ≤ R ≤ 1M	-100 to +100	J, CR05 = F R < 10	-100 to +600	10 ≤ R ≤ 1M	-250 to +250	1M < R	-500 to +300	/	Test Temperature: 25, 125(°C) $\Delta R/R = R_2 - R_1 / R_1 \times 1 / T_2 - T_1 \times 10^6$ $\Delta R/R = \text{Temp. Coefficient (ppm/°C)}$ T ₁ = 25(°C) T ₂ = 125(°C) R ₁ = T ₁ Resistance at (Ω) R ₂ = T ₂ Resistance at (Ω)	/
	Resistance (Ω)	TCR (ppm/°C)													
[*] D, F 10 ≤ R ≤ 1M	-100 to +100														
J, CR05 = F R < 10	-100 to +600														
10 ≤ R ≤ 1M	-250 to +250														
1M < R	-500 to +300														
Short-time Overload	$\Delta R/R$	±(2.0%+0.10 Ω) max. of the initial value	50m Ω max.	(1) Apply 2.0 x rated voltage for 5 sec. (2.5 x rated voltage for Arrays) (2) Wait 30 minutes (3) Measure resistance CR03 = 30V max. CR05 = 50V max. CR10 = 100V max. CR21 = 200V max. CR32 = 400V max. CRA3A, CRB3A, CRC3A = 100V max.	(1) 2A for 5 sec. (CJ03 = 1A) (2) Wait 30 minutes (3) Measure resistance										
Intermittent Overload	$\Delta R/R$	±(5%+0.1 Ω) max. of the initial value	50m Ω max.	(1) Perform 10,000 voltage cycles as follows: ON (2.0 x rated voltage, 2.5 x for Arrays) 1 sec. OFF 25 sec. (2) Stabilization time 30 min. without loading (3) Measure resistance CR03 = 30V max. CR05 = 50V max. CR10 = 150V max. CR21 = 200V max. CR32 = 400V max. CRA, CRB, CRC = 100V max.	(1) Perform 10,000 current cycles as follows: ON (2A) 1 sec. OFF 25 sec. (2) Wait 30 minutes (3) Measure resistance CJ03 = 1A max.										
	Visual	No evidence of mechanical damage intermittent overload													
Dielectric Withstanding Voltage	No evidence of mechanical damage		Apply 500 VAC for 1 min. (CR10 300 VAC) (CR05, CRA3A, CRB3A, CRC3A 300 VAC/1 sec. CR03 50 VAC/min.)												
Insulation Resistance	<ul style="list-style-type: none"> • CR03, CJ03 = 10⁸Ω min. • CR05, CJ05 = 10⁸Ω min. • CR10, CJ10 = 10⁹Ω min. • CR21, CJ21 = 10¹⁰Ω min. • CR32, CJ32 = 10¹²Ω min. • CRA3A, CRB3A, CRC3A = 10⁹Ω min. 		Apply 500V DC (CR05, CRA3A, CRB3A, CRC3A 100V DC CR03 50 VDC)												

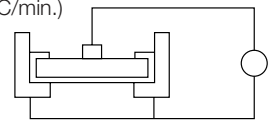

Chip Resistor Arrays



CR, CJ, CRA, CRB, CRC Series - Test Conditions

MECHANICAL CHARACTERISTICS

Item		Standard		Test Conditions	
		Resistor	Jumper	Resistor	Jumper
Terminal Strength	$\Delta R/R$	$\pm(1\%+0.05\Omega)$ max. of the initial value	50m Ω max.	Apply the load as shown: Measure resistance during load application	
	Visual	No evidence of mechanical damage after loading			
Soldering Heat Resistance	$\Delta R/R$	$\pm(1\%+0.05\Omega)$ max. of the initial value	50m Ω max.	Immerse into molten solder at 260 \pm 5 $^{\circ}$ C for 10 \pm 1 sec. Stabilize component at room temperature for 1 hr. Measure resistance.	
	Visual	No evidence of leaching			
Solderability		Coverage \geq 95% each termination end		Immerse in Rogin Flux for 2 \pm 0.5 sec. and in SN62 solder at 235 \pm 5 $^{\circ}$ C for 2 \pm 0.5 sec.	
Anti-Vibration Test	$\Delta R/R$	$\pm(1\%+0.1\Omega)$ max. of the initial value	50m Ω max.	2 hrs. each in X, Y and Z axis. (TTL 6 hrs.) 10 to 55 Hz sweep in 1 min. at 1.5mm amplitude.	
	Visual	No evidence of mechanical damage			
Solvent Resistance	$\Delta R/R$	$\pm(0.5\%+0.05\Omega)$ max. of the initial value	50m Ω max.	Immerse in static state butyl acetate at 20 $^{\circ}$ C to 25 $^{\circ}$ C for 30 \pm 5 sec. Stabilize component at room temperature for 30 min. then measure value.	
	Visual	No evidence of mechanical damage			

ENVIRONMENTAL CHARACTERISTICS

Item		Standard		Test Conditions	
		Resistor	Jumper	Resistor	Jumper
Temperature Cycle	$\Delta R/R$	$\pm(1\%+0.05\Omega)$ max. of the initial value	50m Ω max.	(1) Run 5 cycles as follows: -55 \pm 3 $^{\circ}$ C for 30 min. 125 \pm 3 $^{\circ}$ C for 30 min. Room temp. for 10-15 min. (2) Stabilize component at room temperature for 1 hr. then measure value.	
	Visual	No evidence of mechanical damage			
Low Temperature Storage	$\Delta R/R$	$\pm(2\%+0.1\Omega)$ max. of the initial value	50m Ω max.	(1) Dwell in -55 $^{\circ}$ C chamber without loading for 1000 $^{+48}$ hrs. (2) Stabilize component at room temperature for 1 hr. then measure value.	
	Visual	No evidence of mechanical damage			
High Temperature Storage	$\Delta R/R$	$\pm(3\%+0.1\Omega)$ max. of the initial value	50m Ω max.	(1) Dwell in 125 $^{\circ}$ C chamber without loading for 1000 $^{+48}$ hrs. (2) Stabilize component at room temperature for 1 hr. then measure value.	
	Visual	No evidence of mechanical damage			
Moisture Resistance	$\Delta R/R$	$\pm(3\%+0.1\Omega)$ max. of the initial value	50m Ω max.	(1) Dwell in temp.: 65 $^{\circ}$ C RH90 to 95% RH chamber without loading for 1000 $^{+48}$ hrs. (2) Stabilize component at room temperature for 1 hr. then measure value.	
	Visual	No evidence of mechanical damage			
Life Test	$\Delta R/R$	$\pm(3\%+0.1\Omega)$ max. of the initial value	50m Ω max.	(1) Temp.: 70 \pm 3 $^{\circ}$ C Voltage: (rated voltage) on 90 min. off 30 min. Duration: 1000 $^{+48}$ hrs. (2) Stabilize component at room temperature for 1 hr. then measure value.	
	Visual	No evidence of mechanical damage			
Loading Life in Moisture	$\Delta R/R$	$\pm(3\%+0.1\Omega)$ max. of the initial value	50m Ω max.	(1) Temp.: 40 \pm 2 $^{\circ}$ C RH: 90-95% Voltage Cycle: on 90 min. (rated voltage) off 30 min. Duration: 1000 $^{+48}$ hrs. (2) Stabilize component at room temperature for 1 hr. then measure value.	
	Visual	No evidence of mechanical damage			

Packaging of Chip Component



Automatic Insertion Packaging

TAPE AND REEL

REEL DIMENSIONS

millimeters (inches)

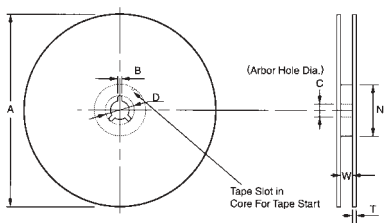

Tape Size	A Max.	B Min.	C	D Min.	N Min.	W	T Max.
8mm	178 (7)	1.50 (0.059)	13.0±0.50 (0.512±0.020)	20.2 (0.795)	50 (1.969)	10.0±1.50 (0.394±0.059)	2.50 (0.098)
	260 (10)						

Metric dimensions will govern.
English measurements rounded and for reference only.

millimeters (inches)

PUNCHED TAPE CONFIGURATION 8MM TAPE ONLY

Tape Size	D ₀	E	P ₀	P ₂	W	F
8mm	1.50 ^{+0.10} / _{-0.00} (0.059 ^{+0.004} / _{-0.000})	1.75±0.10 (0.069±0.004)	4.0±0.10 (0.157±0.004)	2.00±0.05 (0.079±0.002)	8.00±0.20 (0.135±0.008)	3.50±0.05 (0.138±0.002)

VARIABLE DIMENSIONS

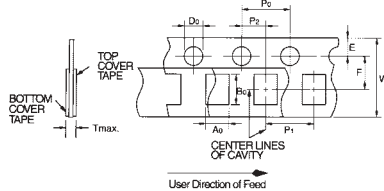

Style	P ₁	A ₀	B ₀	T max.
CR/CJ03 CR/CJ05	2.00±0.10 (0.079±0.004)	0.65±0.10 (0.026±0.004)	1.15±0.10 (0.045±0.004)	0.60 (0.024)
CR/CJ/FR10	4.00±0.10 (0.157±0.004) or 2.00±0.10 (0.079±0.004)	1.10±0.20 (0.043±0.008)	1.90±0.20 (0.075±0.008)	1.10 (0.043)
CR/CJ/FR21	4.00±0.10 (0.157±0.004)	1.65±0.20 (0.065±0.008)	2.40±0.20 (0.094±0.008)	
CR/CJ/FR32		2.00±0.20 (0.079±0.008)	3.60±0.20 (0.142±0.008)	
CRB1A		1.90±0.20 (0.075±0.008)	1.90±0.20 (0.075±0.008)	
CRA3A CRB3A CRC3A		2.00±0.20 (0.079±0.008)	3.60±0.20 (0.142±0.008)	
CRB2A		2.00±0.10 (0.079±0.004)	1.25±0.20 (0.049±0.008)	

PUNCHED CARRIER

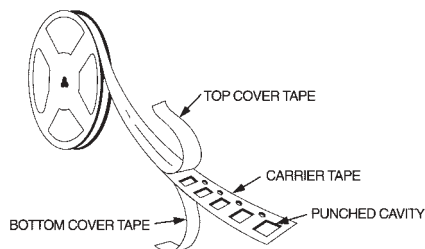

Recommended Land Patterns



RECOMMENDED LAND PATTERNS IS REFERRED THE FOLLOWING FOR EXAMPLE

millimeters (inches)

CRA3A4E Series

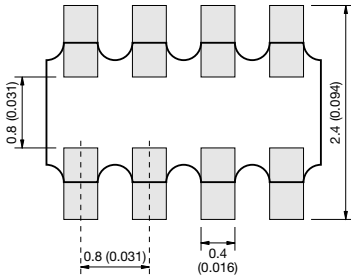

RNA4A8E Series

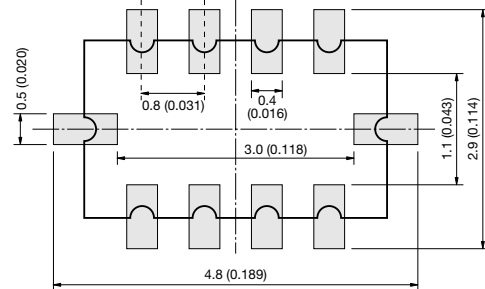

CRB1A2E Series

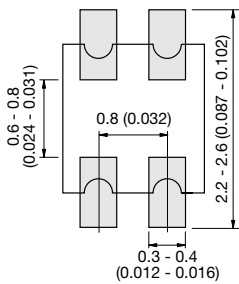

CRB3A4E Series

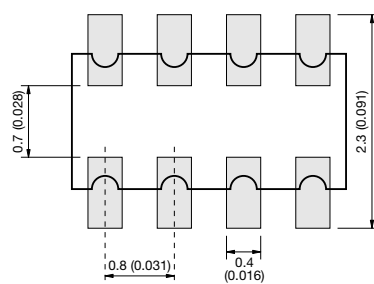

CRB2A4E Series

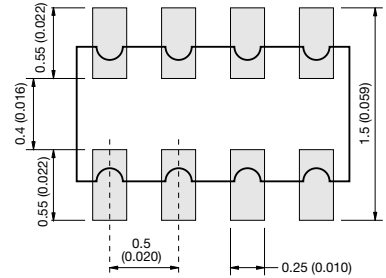

CRC3A4E Series

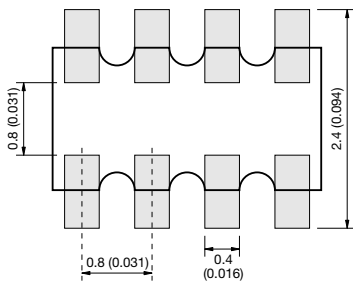

CRC2A4E Series

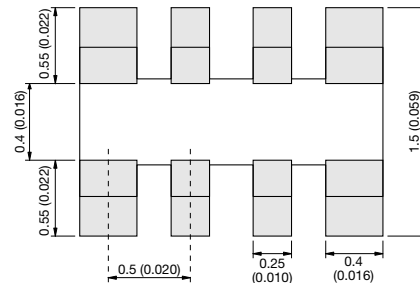

CRC4A8E Series

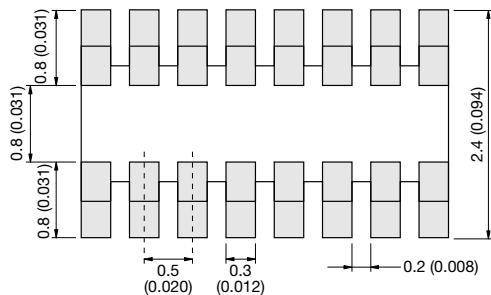

CRB6A8E Series

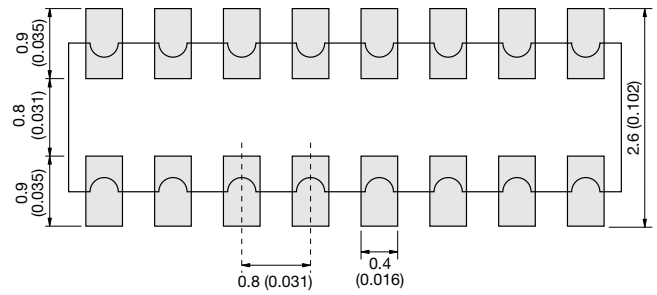

SAMPLE KIT PART NUMBERS

Part Number	Description
CRJ-E6-Kit	Combination 0603, 0805, 1206, 5% parts 21 values per case size 100 pcs. per value (approx.)
CR05-E12-Kit	0402, 5% parts 63 values 100 pcs. per value
CR10J-E12-Kit	0603, 5% parts 63 values 100 pcs. per value (approx.)
CR21J-E12-Kit	0805, 5% parts 63 values 100 pcs. per value (approx.)
CR32J-E12-Kit	1206, 5% parts 63 values 100 pcs. per value (approx.)
CR05F-E24-Kit	0402, 1% parts 63 values 100 pcs. per value
CR10F-E24-Kit	0603, 1% parts 63 values 100 pcs. per value
CR-ARRAY-E6-Kit	Arrays, Various styles, CRA, CRB, CRC, RNA, 5% 13 values per style (approx.) 20 pcs. per value